

**art. P1040**

Tappo copristarter a tenuta stagna  
*Waterproof starter cover*

1

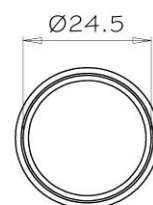
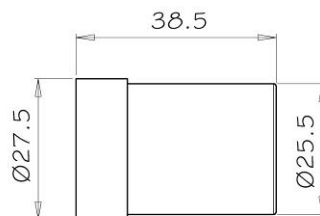

**art. P1058**

Tappo di protezione per presa P1035  
*Protective cover for sockets P1035*

2

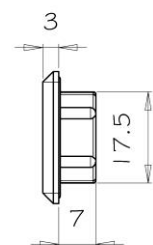
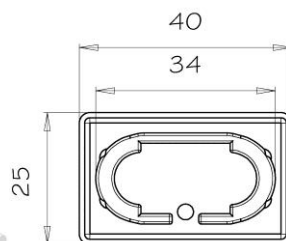

**art. P1069**

Tappo di protezione per presa P1067 e P1077  
*Protective cover for sockets P1067 and P1077*

3

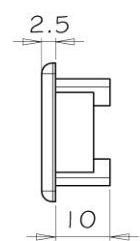
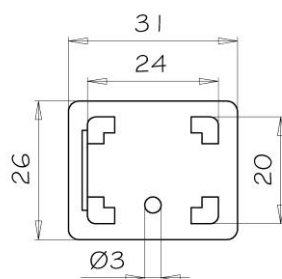
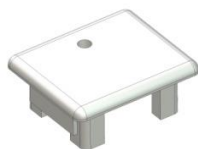

**art. P1070**

Tappo di protezione per vano presa su intercapedine  
*Protective cover for cavity wall socket box*

4

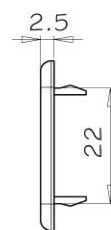
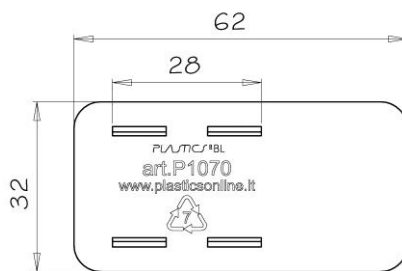

**art. P1074**

Tappo di protezione per presa P1041/B  
*Protective cover for socket P1041/B*

5

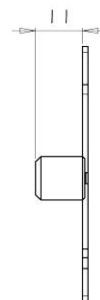
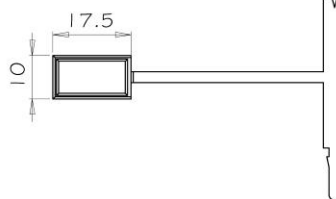
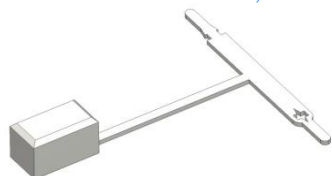

art. P1089/A  
Tappo di protezione per presa P1081  
*Protective cover for socket P1081*

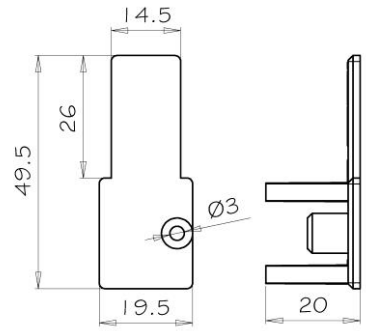

6

art. P1090  
Tappo di protezione per sede presa P1081 su intercapedine  
*Protective cover for cavity wall socket box*

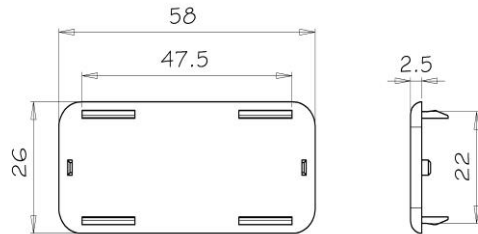

7

art. P1110  
Tappo di protezione con denti di aggancio per presa P1072  
*Protective cover for plug P1072*

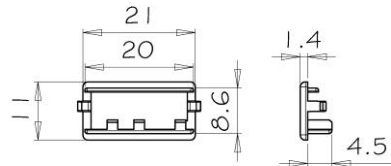

8

art. P1131  
Tappo di protezione per presa P1124  
*Protective cover for plug P1131*

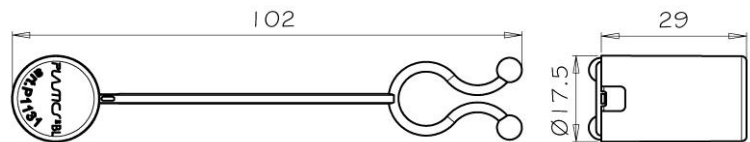

9